

DENTAL
INSTRUMENTS
Catalog



Dental Instruments

PERIODONTAL INSTRUMENTS



Handle Options

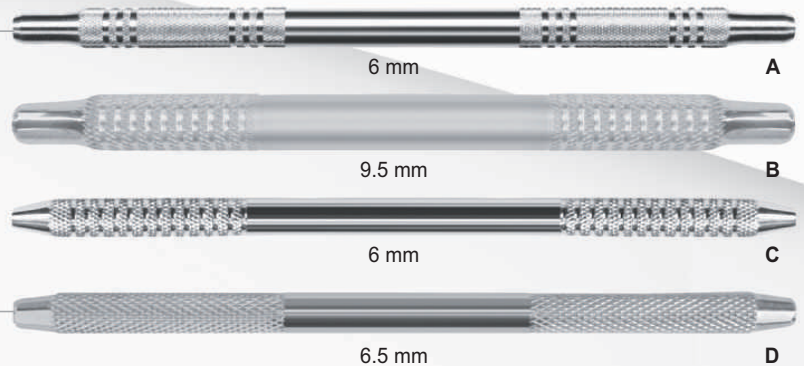

TE-3000
Jacquette 3-4



TE-3001
Jacquette 3-U15



TE-3002
M23



TE-3003
Jacquette 14-15



PE-3004
Jacquette 4-U5



TE-3005
U15-30



TE-3006
Jacquette 3-U5



TE-3007
Jacquette 4-U15



TE-3008
U15-33

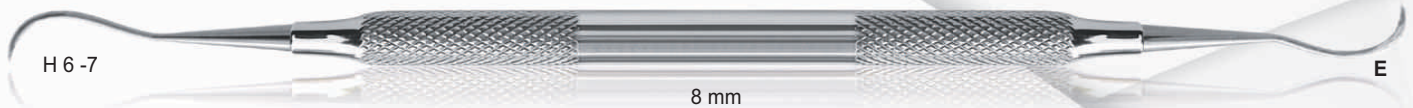

TE-3009
Eage Claw



TE-3010
Curaler - N 137



TE-3011
S 311-312



TE-3012
N3



TE-3013
Morse 0-00



TE-3014
Eagle Talon



TE-3015
N135



TE-3016
N1



TE-3017
SE Nebraska 128
(Single End)



TE-3018
N2

Tollot

are crafted by hand. Tips are fabricated individually by highly skilled precision technicians. Each instrument is continually held to strict quality controls during each stage of manufacturing, with tapering point working end. Well suitable for inter-dental cavities.

DIAGNOSTIC

PROBES

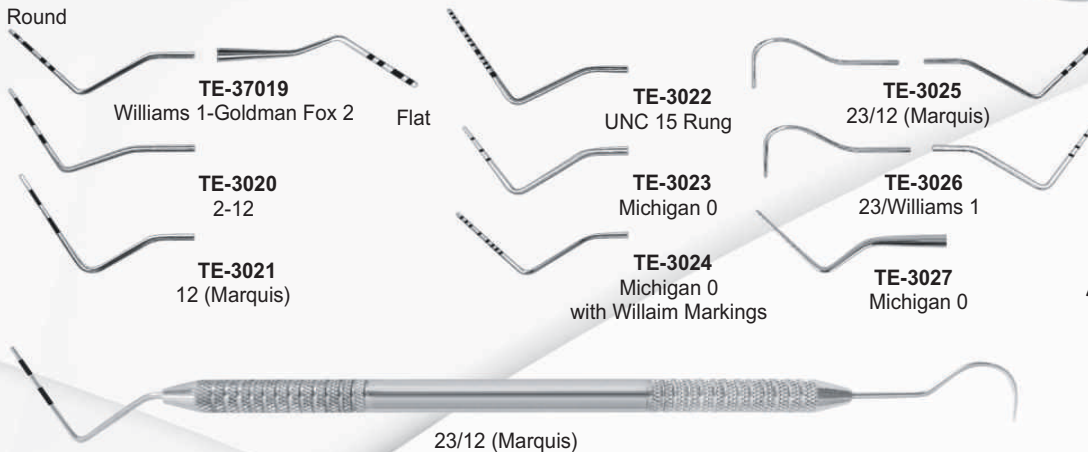
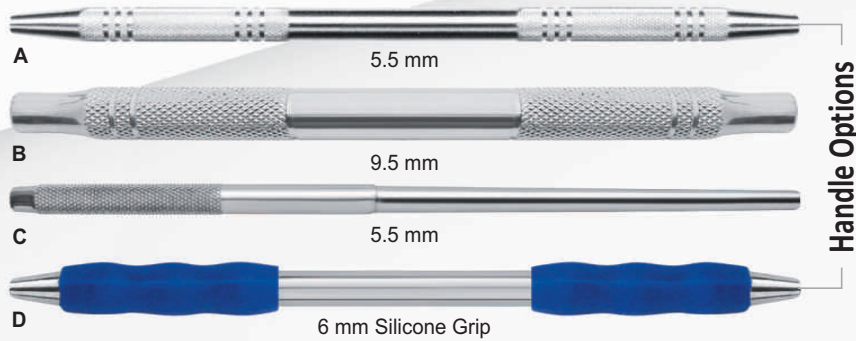

Available with/without colour marking

Probes are precision fabricated to provide accuracy for intraoral gauging. Probes with extra fine, sharp points for diagnosing tartar or concretions, caries, filling and tooth morphology. All probe instruments are designated in millimeters. Avoid temperature above 200 °C / 398 F°, at which point your Hi-Lite Probe markings may become discolored.

EXPLORERS

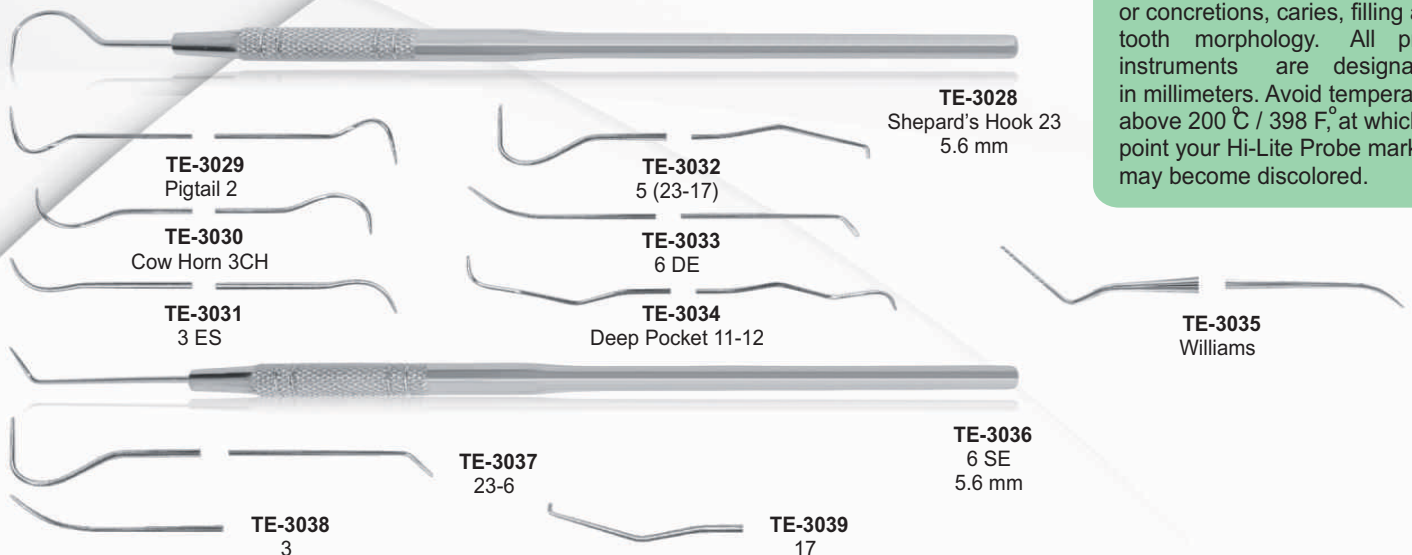

Dental Instruments

DIAGNOSTIC

HANDLES FOR MIRRORS

Handles with M2.5 Thread



5.5 mm

TE-3040



6.5 mm

TE-3041



10 mm

TE-3042



6.5 mm

TE-3043



6.5 mm

TE-3044

Note: All Mouth Mirrors are Available in Plane & Magnifying Glass

MOUTH MIRRORS



TE-3045
Back Surface



PE-3046
Rhodium Front Surface

Sizes:     
16 mm 18 mm 20 mm 22 mm 24 mm

Front surface is rhodium coated, reflective coating is on the upper side of the mirror glass, in this way a clear and undistorted image is achieved.



Resection Mirror (Mirror with Fixed Handle)

TE-3047



TE-3048
Mirror Kits

RESTORATIVE

KNIVES



WAXING INSTRUMENTS

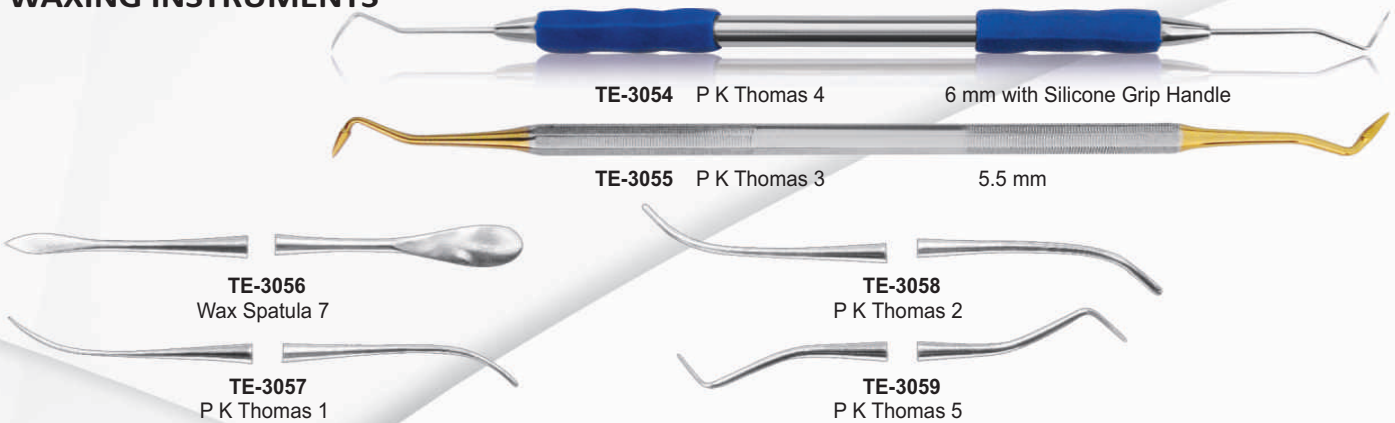

MARGIN TRIMMERS

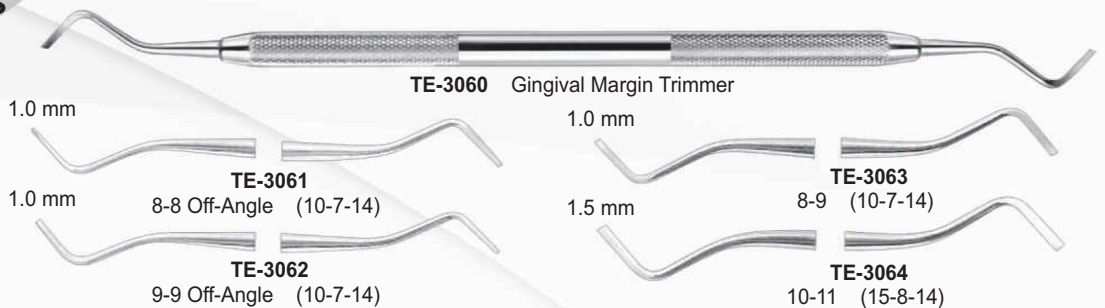

ENDODONTICS SPREADERS PLUGGERS



Dental Instruments

RESTORATIVE

PLASTIC FILLING CARVERS

Handle Options

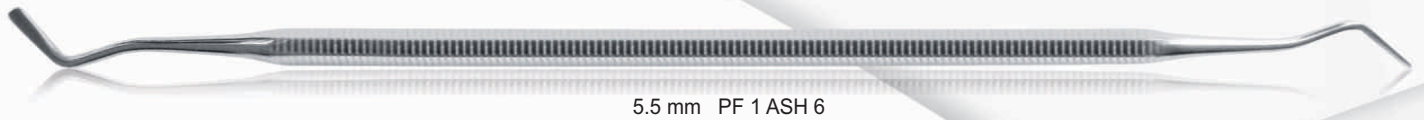
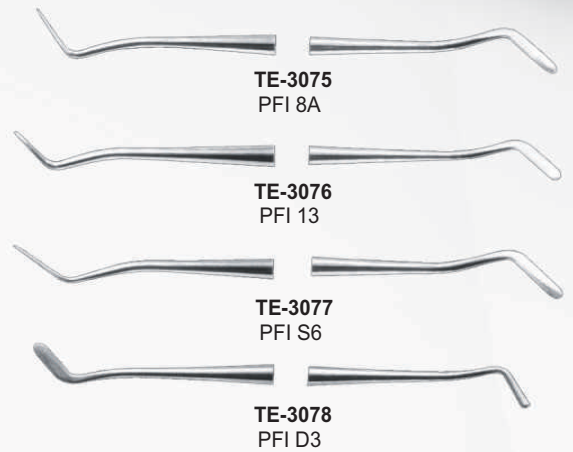
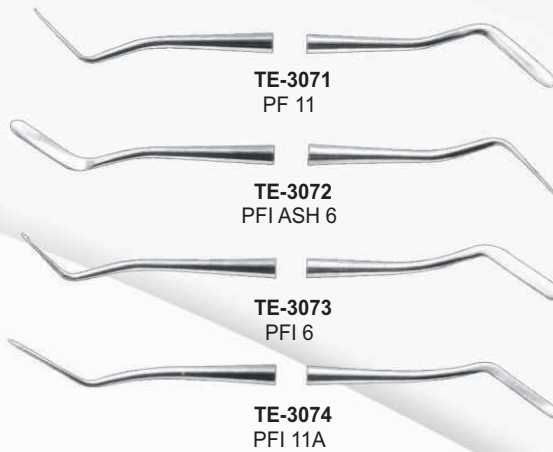
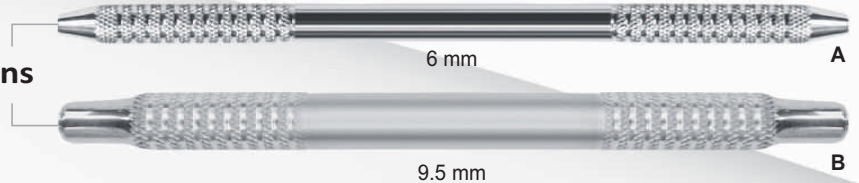

PLASTIC FILLING

TITANIUM NITRIDE COATING IS SIGNIFICANTLY HARDER THAN STEEL.

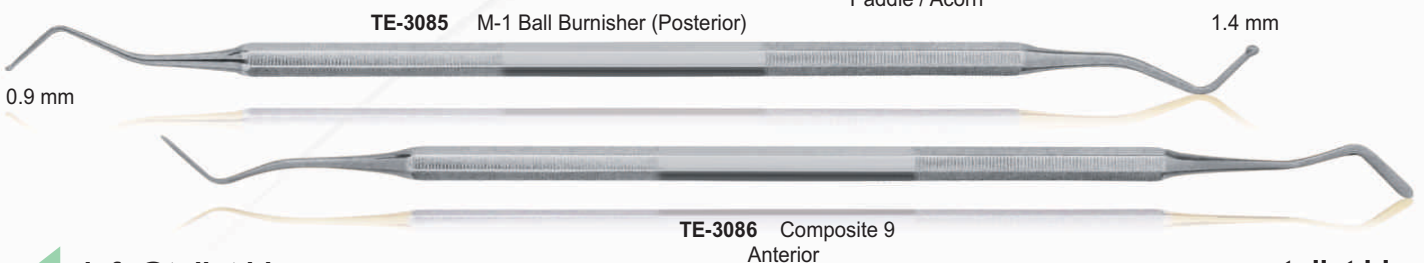
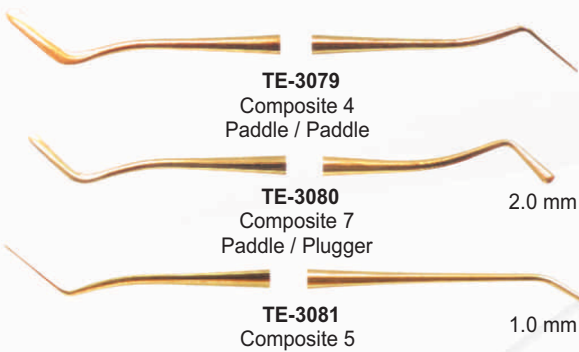

RESTORATIVE & SINUS LIFT

CORD PACKERS

Handle Options



A 6.5 mm



B 6 mm



TE-3088-A
DC 1-2 8 mm



TE-3087
CSI-1 Serrated

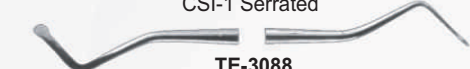

TE-3088
Round



TE-3089
Round Off-Angle

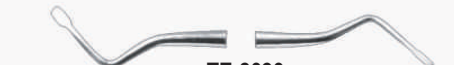

TE-3090
Guyer 7 Serrated

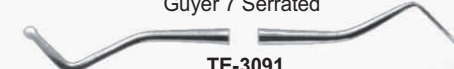

TE-3091
Round Serrated

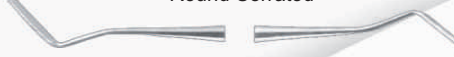

TE-3092
1 Off-Angle



TE-3093
Guyer 7 Off-Angle
Serrated

DISCOID-CLEOID



TE-3094
DC 4-5



TE-3095
UW-D5



TE-3096
5T



TE-3097
89-92



TE-3098
DC 3-6

All of our instruments are hand sharpened by highly trained technicians to provide sharper, longer lasting tips and edges.

SINUS LIFT ELEVATORS



TE-3099

8 mm

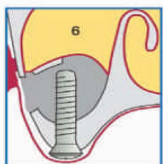
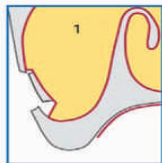

TE-3100
Measuring
Probe



TE-3101
Elevator 2



TE-3102
Will



TE-3103
Myron Nevins



TE-3104
Will
3 mm
4 mm



TE-3105
Iglhaut
sharp/blunt

Dental Instruments

RESTORATIVE

CONDENSERS / PLUGGERS (NON-SERRATED)

HANDLE OPTIONS

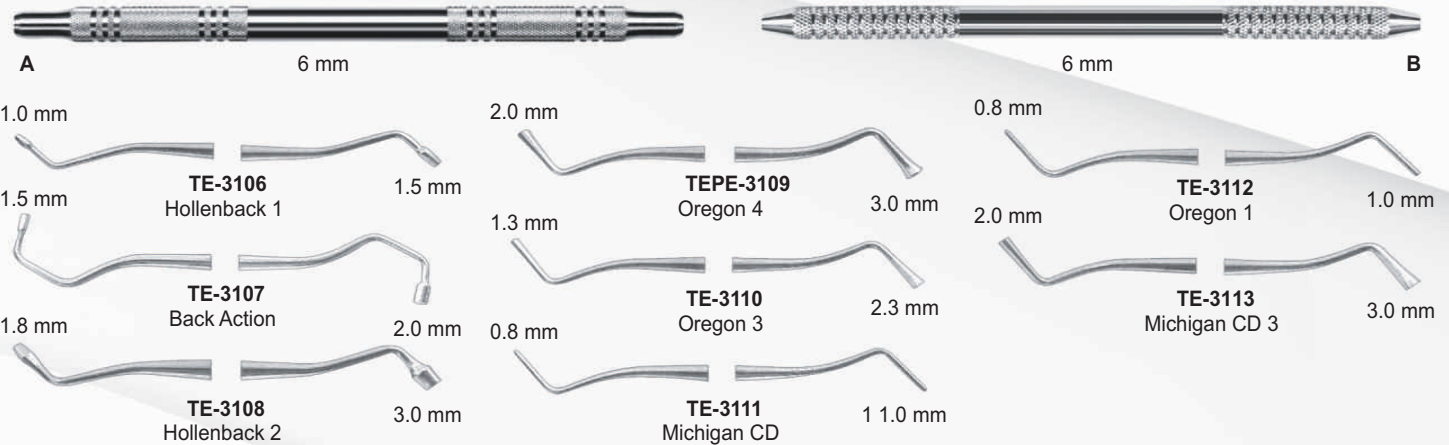

BURNISHERS

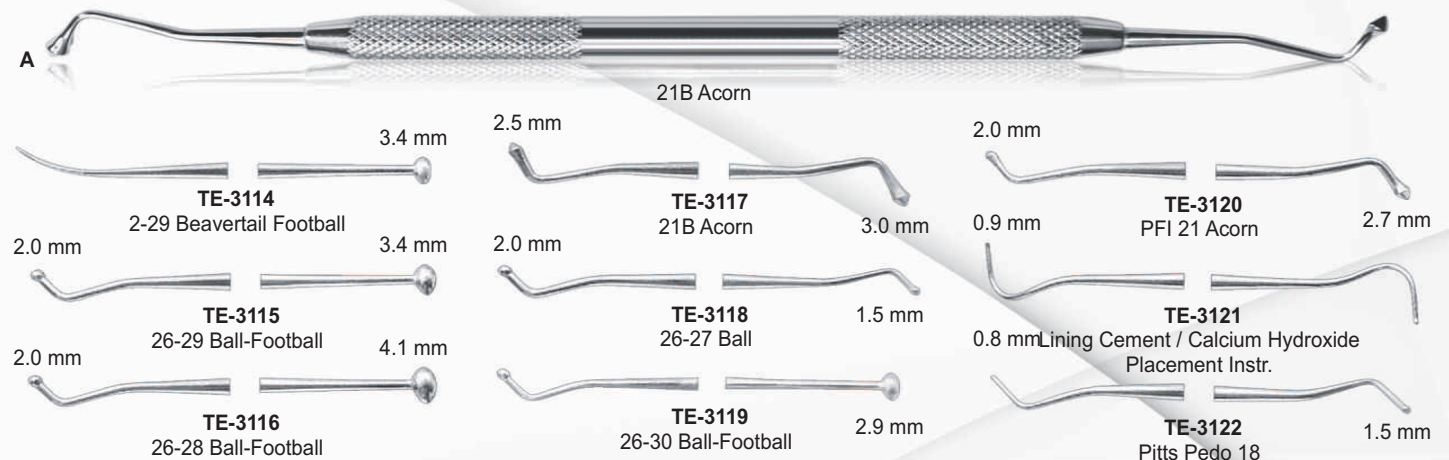

CARVERS

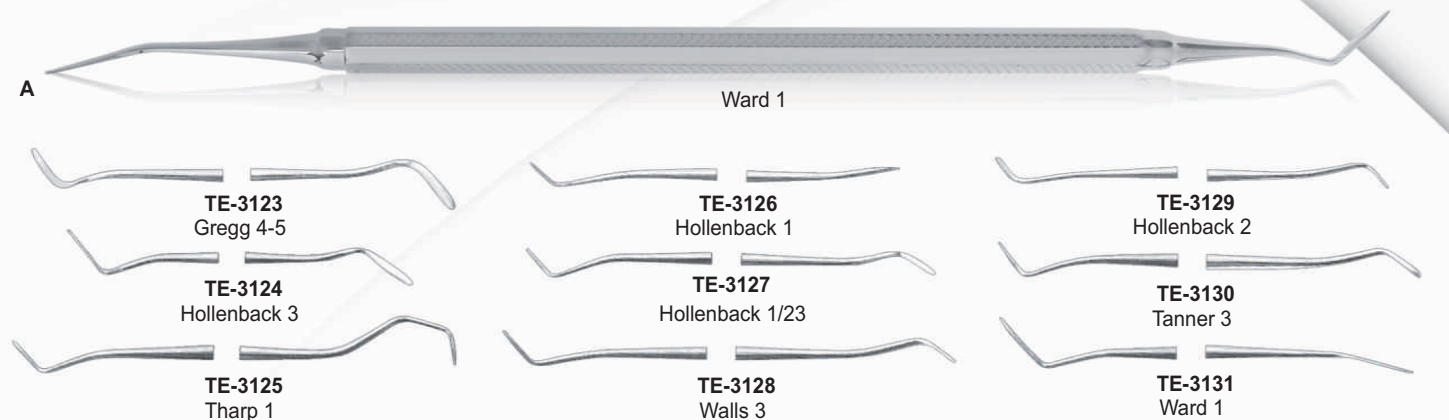

HAND CUTTING INSTRUMENTS

CHISELS



A 6 mm Stainless Steel Double End (Standard)



TE-3132
Wedelsteadt 3-4
(11.5-15-3)



TE-3134
Wedelsteadt 5-6
(15-15-3)



TE-3133
Binangle 8-9
(20-9-8)



TE-3135
Binangle 11-12
(15-8-8)

Tollot excavators, used for the removal of softened carious dentin, are equipped with a spoon-shaped working end for work on deep areas and a round working end for tissue-saving cavity preparation.

EXCAVATORS



1.2 mm 6 mm A



1.0 mm 6.6 mm B



2.3 mm **TE-3136**
17



1.9 mm **TE-3143**
64-65



1.5 mm **TE-3137**
20



1.5 mm **TE-3144**
74-75



1.5 mm **TE-3138**
42-43
(15-8-14)



1.1 mm **TE-3145**
E-2
(15-9-15)

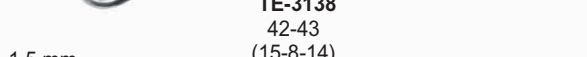

1.2 mm **TE-3139**
70-71

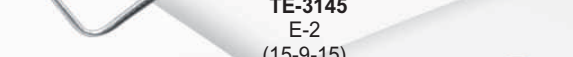

1.0 mm **TE-3146**
40-41
(11-7-14)

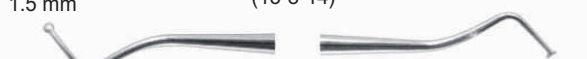

1.5 mm **TE-3140**
E-1
(12-9-15)

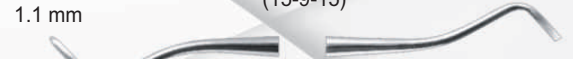

2.5 mm **TE-3147**
66-67

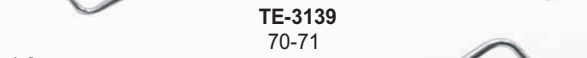

1.15 mm **TE-3141**
18

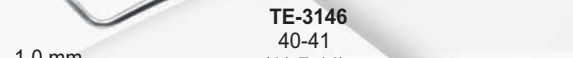

2.5 mm **TE-3148**
78-79



1.15 mm **TE-3142**
38-39
(11.5-7-14)



8 mm **TE-3149**
E-3
(25-9-15)

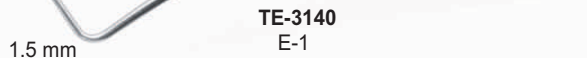

8 mm C



74-75



74-75

Dental Instruments

CURETTES



GRACEY STANDARD

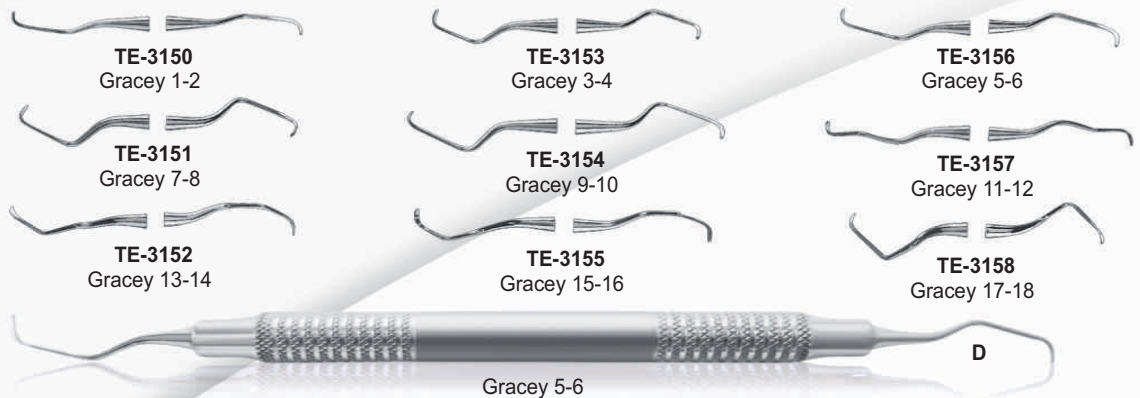
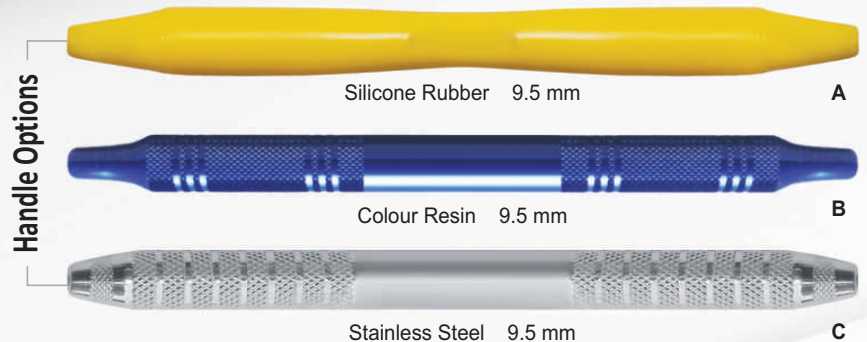

Application field of original Gracey Curettes

1-2, 3-4, 5-6
Front teeth

7-8, 9-10
Bicuspid and molars

11-12, 15-16
Bicuspid and molars mesial, furcation: mesial part of the distal root

13-14, 17-18
Bicuspid and molars distal, furcation: distal part of the mesial root.

UNIVERSAL CURETTES

HANDLE OPTIONS

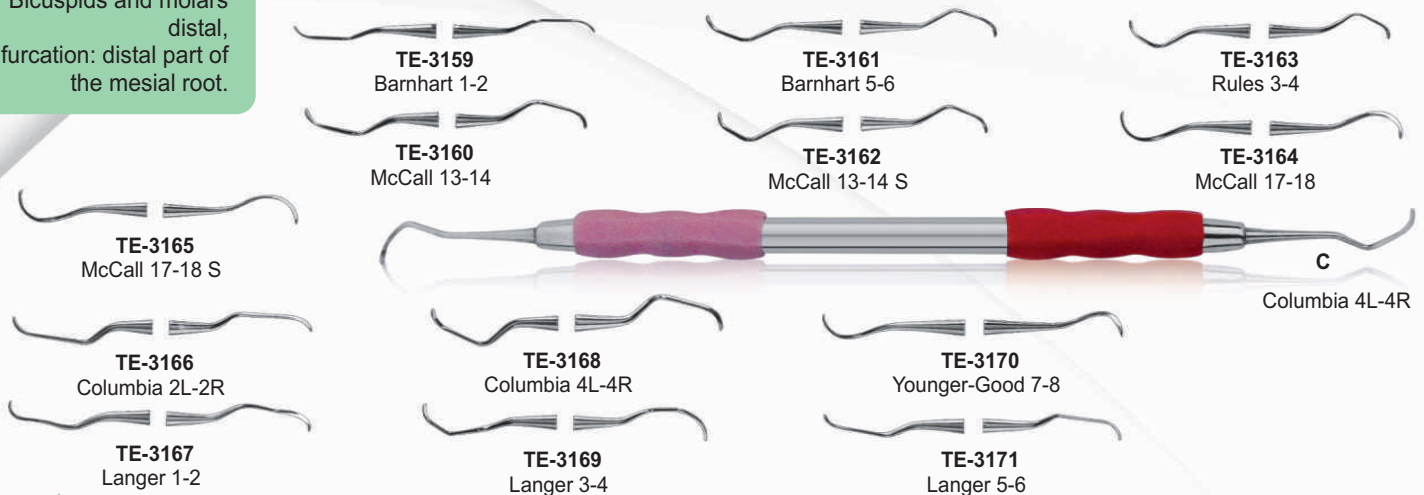

LUXATING SETS

Handle Options

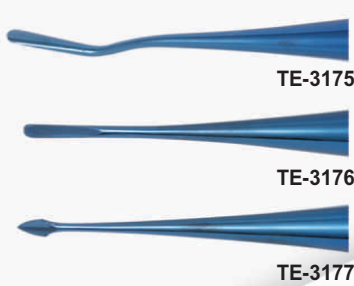
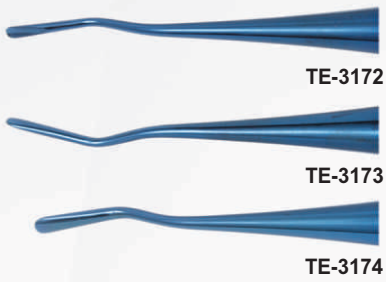

Available Handle

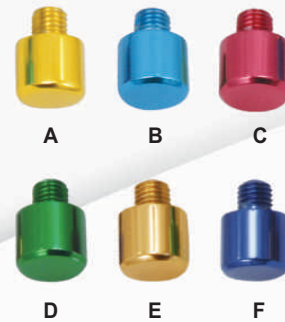

GRACEY CURETTE

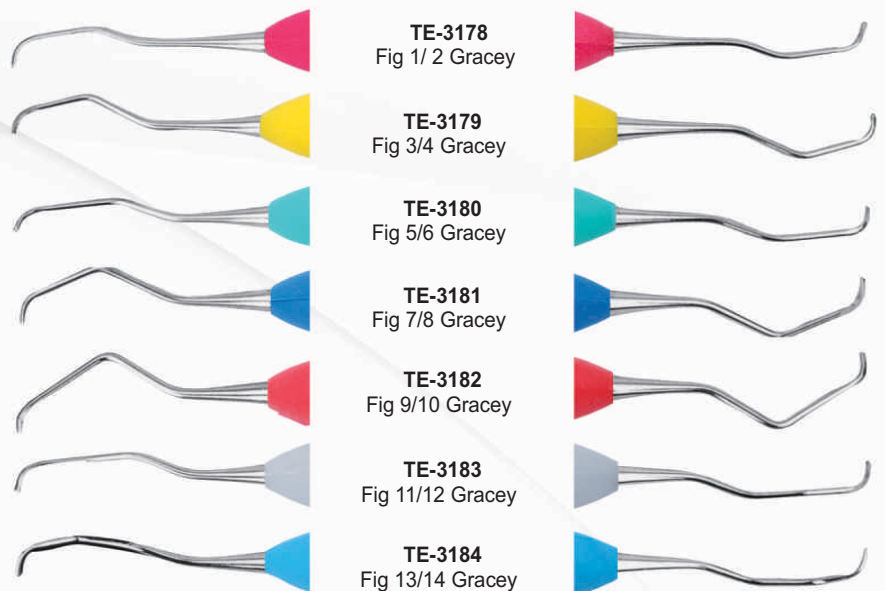
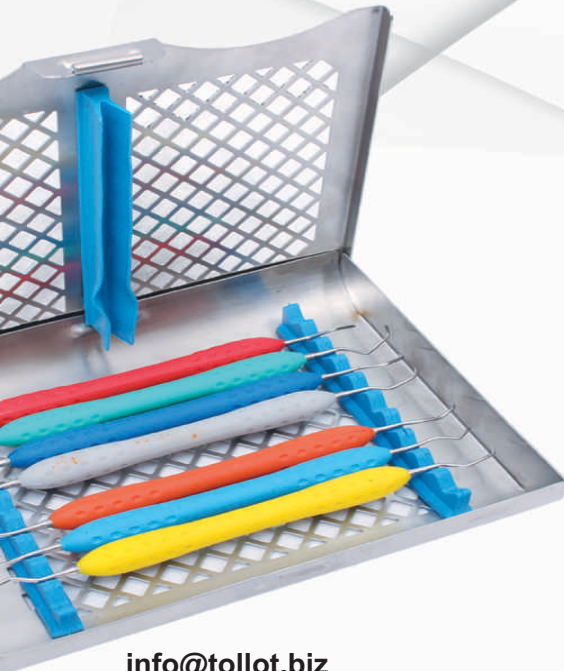

Dental Instruments

SURGERY

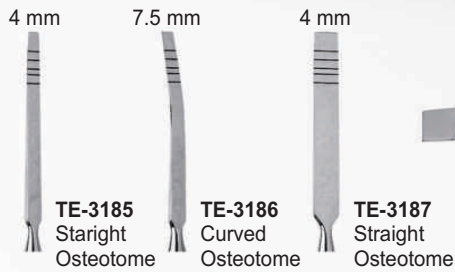

BONE SPLITTING INSTRUMENTS



PERIOSTEALS ELEVATOR

For reflecting and retracting the mucoperiosteum after incisions of the gingival tissue.

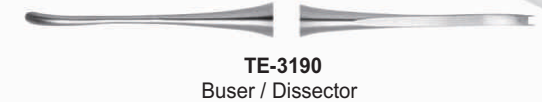

CHEEK, LIP RETRACTOR AND STANDS

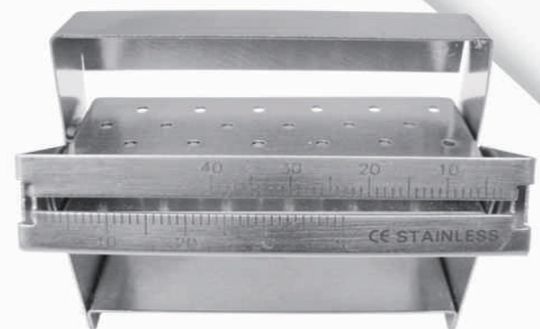
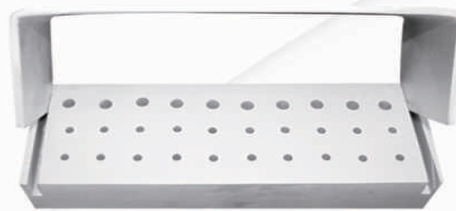

BONE MANAGEMENT

BONE FILES



TE-3201
Bone Files
Miller- Colburn 1 X- Cut
18 cm



Fig. 1



Fig. 2



Fig. 3



Fig. 4



Fig. 5

CURETTES, SCRAPERS, CHISELS AND GAUGES



TE-3210
Miller & Lucas
Spoon Shape
2.2mm, 2.8 mm
6

TE-3211
Will
2.5mm



TE-3202
Articulating Paper Forcep
Miller
15 cm



TE-3203
Williger 14.5 cm

Sharp Spoon

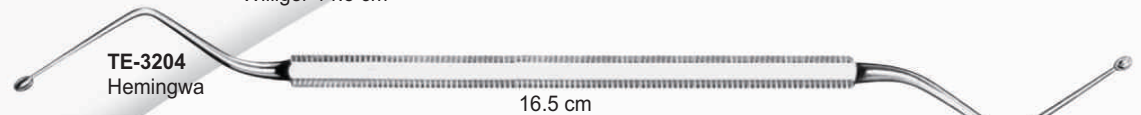

TE-3204
Hemingwa

16.5 cm



TE-3205
Will Sharp Spoon 16.5 cm

2,5 mm

3,5 mm



TE-3206
Periosteal Elevator Freer (Sharp / Blunt)



TE-3207
Bone Chisel Partsch 17 cm (3-6 mm)



Partsch **TE-3208**
Gouge Width 4 mm, 5 mm, 6 mm, 7 mm

17 cm (3-6 mm)



TE-3209
Gouge
17 cm (3-6 mm)

Dental Instruments

STANDARD SET OF FORCEPS SYSTEM



TE-3212
Standard Set Of Forceps System Stand



TE-3213
Right



TE-3214
Left



TE-3215
Easy Access To Molars
Right



TE-3216
Easy Access To Molars
Left



TE-3217
Upper Right



TE-3218
Upper Left



TE-3219
Upper Anterior



TE-3220
Lower Universal

EXTRACTING FORCEPS (ENGLISH PATTERN)



TE-3221
Lower Third Molars
Fig. 79



TE-3222
Upper Centrals and Canines
Fig. 7



TE-3223
Upper Molars Left
Fig. 18



TE-3224
Upper Pre Molars
Fig. 7



TE-3225
Upper Roots, Right
Fig. 17



TE-3226
Lower Roots
Fig. 33



TE-3227
Upper Third Molars
Fig. 67



TE-3228
Upper Roots
Fig. 51



TE-3229
Lower Molars
Fig. 22



TE-3230
Lower Molars
Fig. 22



Dental Instruments

EXTRACTING FORCEPS (ENGLISH PATTERN)



TE-3231
Upper Roots
Fig. 51



TE-3236
Upper Third Molars
Fig. 67



TE-3232
Lower Third Molars
Fig. 79



TE-3237
Upper Centrals and Canines
Fig. 7



TE-3233
Upper Pre Molars
Fig. 7



TE-3238
Upper Molars Left
Fig. 18



TE-3234
Upper Roots, Right
Fig. 17



TE-3239
Lower Molars
Fig. 22



TE-3235
Lower Roots
Fig. 33



TE-3240
Lower Molars
Fig. 22

EXTRACTING FORCEPS (CHILDREN & AMERICAN PATTERN)



TE-3241
Upper Molars
Klein
Fig. 220



TE-3242
Upper Roots
Klein
Fig. 219



TE-3243
Upper Incisors
Klein
Fig. 217



TE-3244
Upper Pre Molars
Klein
Fig. 218



TE-3245
Lower Incisors
Klein
Fig. 221



TE-3246
Lower Molars
Klein
Fig. 222



TE-3247
Lower Roots
Klein
Fig. 223



TE-3248
Harris Fig. 18 R
For Upper Molars, Right



TE-3249
Fig. 203
For Lower Incisors,
Premolars And Roots



TE-3250
Fig. 17
For Lower Molars



TE-3251
Fig. 222
For Lower Wisdom Teeth



TE-3252
Hull Fig. 101
Universal Tooth
Forceps



TE-3253
Cryer Fig. 151
For Lower Incisors, Canines,
Premolars And Roots

Dental Instruments

ELEVATORS

ROOT AND LUXATING ELEVATORS

Luxating instruments have thin sharp blades that are used to cut periodontal ligaments.



SPLINTER ELEVATOR



Handle Options



ROOT ELEVATORS



DENTAL SYRINGES



TE-3277 (1.8ML)
TE-3278 (2.2ML)
Angled



TE-3279 (1.8ML)
TE-3280 (2.2ML)



TE-3281 (1.8ML)
TE-3282 (2.2ML)



TE-3283 (1.8ML)
TE-3284 (2.2ML)

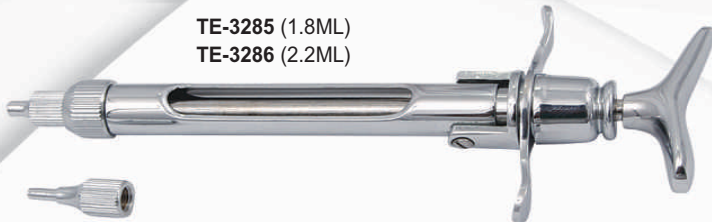

TE-3285 (1.8ML)
TE-3286 (2.2ML)



TE-3287 (1.8ML)
TE-3288 (2.2ML)
Angled

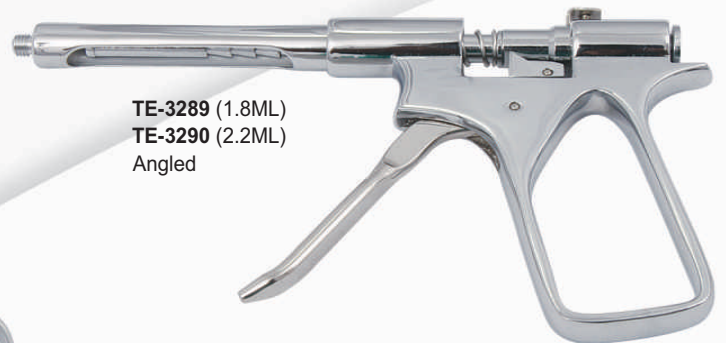

TE-3289 (1.8ML)
TE-3290 (2.2ML)
Angled

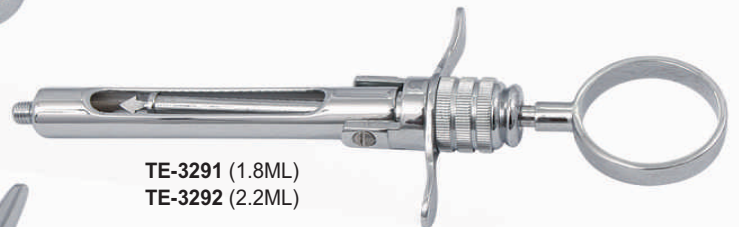

TE-3291 (1.8ML)
TE-3292 (2.2ML)



TE-3293 (1.8ML)
TE-3294 (2.2ML)

Dental Instruments

RESTORATIVE & CROWN REMOVERS

MATRIX RETAINERS



TE-3295
Ivory Nystrom
Left / Right
65 mm



TE-3296
Matrix Retainer
Tofflemire



TE-3297
Matrix Retainer Ivory B
05 mm, 06 mm, 07 mm

DRESSING PLIERS



TE-3298
Merriam 16 cm (Smooth, Serrated)



TE-3299
Flagg 16 cm (Smooth, Serrated)



TE-3300
Flagg 16 cm (Smooth, Serrate)



TE-3301
College 15 cm (Smooth, Serrated)



TE-3302
Perry 13 cm (Smooth, Serrated)

CROWN INSTRUMENTS



TE-3303
Orthodontic Band Pusher



TE-3304
Crown Remover
Automatic with 5 insets including lock and key



TE-3305
Crown-Butler with 3 insets
3/4, chrome plated brass



TE-3306
Morrel Crown Remover
(Manual) with 5 insets



IMPRESSION TRAYS & RESTORATIVE

Assorted Colours Moulded Plastic

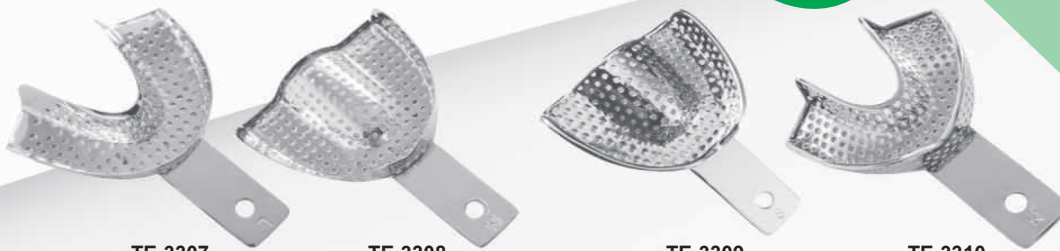

TE-3307

Perforated Without Retention Rim

TE-3308

Unperforated With Retention Rim

TE-3309

Perforated With Retention Rim

TE-3310



		mm	mm
L0	XXS	56	44
L1	XS	66	50
L2	S	70	52
L3	M	73	56
L4	L	76	58
L5	XL	78	60



TE-3311

TE-3312

Also Available Partial Trays



TE-3313

Perforated for edentulous upper jaws

TE-3314

Unperforated For toothed lower jaws



TE-3315
Perforated For Partial Impressions right R1, R2, R3



TE-3316
Unperforated For Partial Impressions Left L1, L2, L3

		mm	mm
L		79	70
M		76	67
S		73	60

		mm	mm
L		79	70
M		76	67
S		73	60

13 cm, 15 cm

AMALGUM CARRIER, WELL AND GUN



TE-3317
23 cm

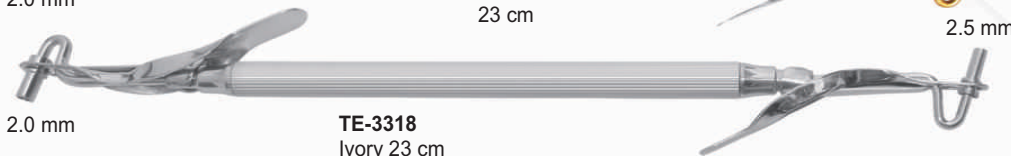

TE-3318
Ivory 23 cm
Also Available Single Ended 17.5 cm



TE-3319
Amalgum Well
H 1.5 cm / D 3.5 cm
H 3.5 cm / D 3.5 cm



TE-3320
Amalgum Gun
30° 45° 90°

Dental Instruments

ISOLATION & RESTORATIVE INSTRUMENTS

RUBBER DAM INSTRUMENTS



TE-3321
Rubber dam punch
Anisworth 16 cm
also available Ivory with 1 and 2 rows of holes



TE-3322
Rubber dam
clamp forcep Brewer
17 cm



TE-3323
Rubber dam clamp forcep
Stokes
17 cm

RUBBER DAM CLAMP TE-3324

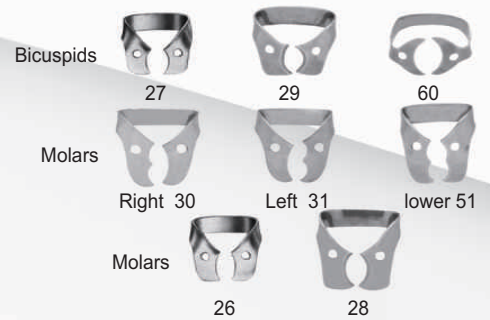

TE-3324-A
Rubber dam frame
big/small 15X15 cm
Stainless Steel/Plastic

WAX AND PLASTER KNIVES, CEMENT SPATULAS



13 cm,
17.5 cm
TE-3325
Wax knives with
wooden handles
Fahenstock



TE-3326
Lessman
with grooved blade
13 cm, 17 cm



13 cm
TE-3327
Fahenstock
All metal wax knife
13 cm



5.5mm
TE-3328



angular
8.0mm
TE-3329



round
8.0 mm
TE-3330

SALIVA EJECTOR



TE-3331



TE-3332



TE-3333



TE-3334

Available in Stainless Steel, Aluminum & Titanium

ORTHODONTIC PLIERS



Screw Lock
Box = S/L



Box Lock = B/L



Allen Wrench
Box = AW/L

All Pliers & Cutters Could Be Provided
In Adjustable Lap Joint Fitting,
Box Joint Fitting & Lap Joint Fitting.

All Pliers and Cutters are available
with Tungsten Carbide Tips.



TE-3335
Orthodontic Plier Stand

This Is A Matt Finish Metal
Orthodontic Plier Stand.
This Plier Stand Is Durable
And Strong. This Orthodontic
Plier Stand Is Orthodontist
First Choice.



TE-3336
Rectangular Arch
Forming Plier



TE-3337
Standard How
Utility, Plier

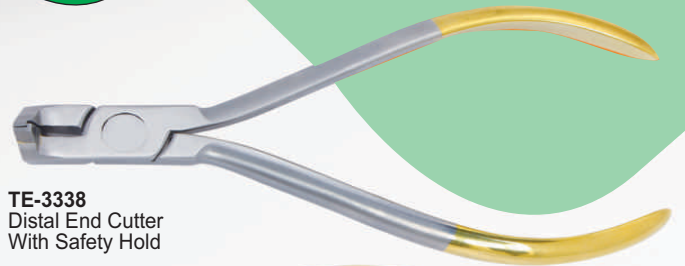

TE-3338
Distal End Cutter
With Safety Hold



TE-3339
Three Jaw
Plier, Anderer



TE-3340
Bird Beak
Plier



TE-3341
Posterior Band
Removing Plier

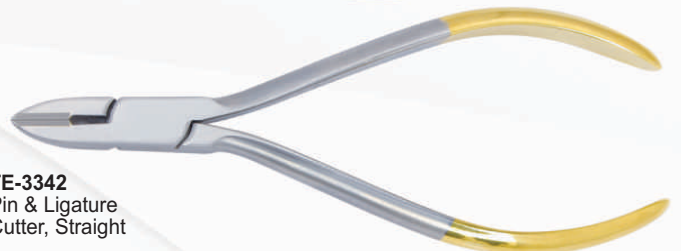

TE-3342
Pin & Ligature
Cutter, Straight



TE-3343
Utility Plier, Weingart

Dental Instruments INSTRUMENTS CASSETTES & STANDS



TE-3344
Instruments Cassettes
5 Pieces, 7 Pieces, 10 Pieces & 20 Pieces



TE-3345
Instruments Cassettes
5 Pieces, 7 Pieces, 10 Pieces & 20 Pieces

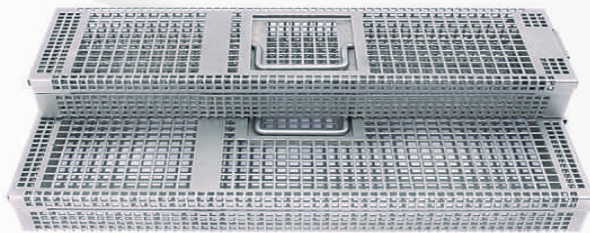

TE-3346
Instruments Cassette
7 Pieces & 10 Pieces

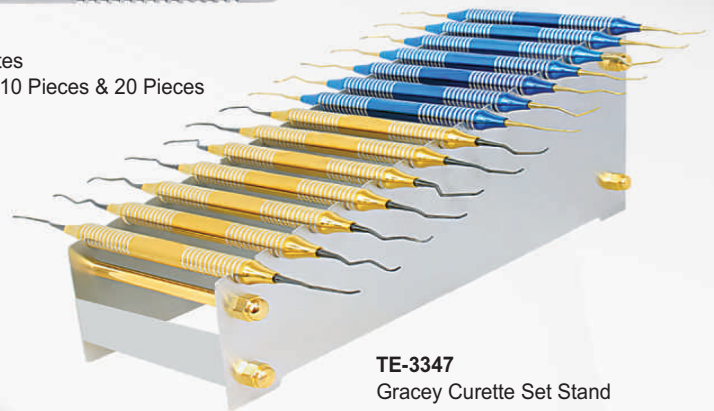

TE-3347
Gracey Curette Set Stand



TE-3348
Instruments Cassettes
10 Pieces

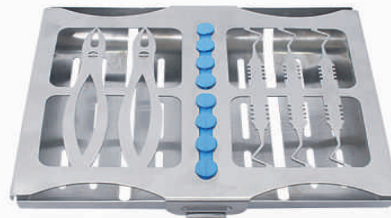

TE-3349
Instruments Cassettes
20 Pieces

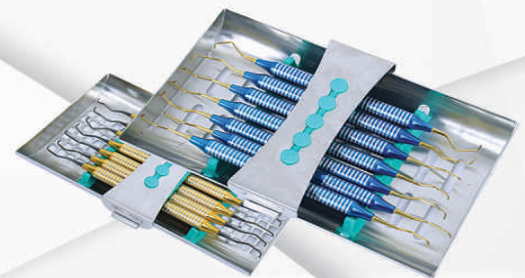

TE-3350
Gracey Curette Set Cassettes



TE-3351
Instruments Cassettes
20 Pieces



TE-3352
Sterilization Basket & Tray
Size: 11" Width X 22" Length
Depth: 2", 3", 4", 5", 6"



TE-3353
Sterilization Basket & Tray
Size: 11" Width X 16" Length
Depth: 2", 3", 4", 5", 6"



TE-3354
Sterilization Basket & Tray

OSTEOTOMES & SINUS LIFT ELEVATORS



TE-3355



TE-3356



TE-3357



TE-3358



TE-3359



TE-3360



TE-3361



TE-3362



TE-3363

Dental Instruments

SINUS LIFT ELEVATORS

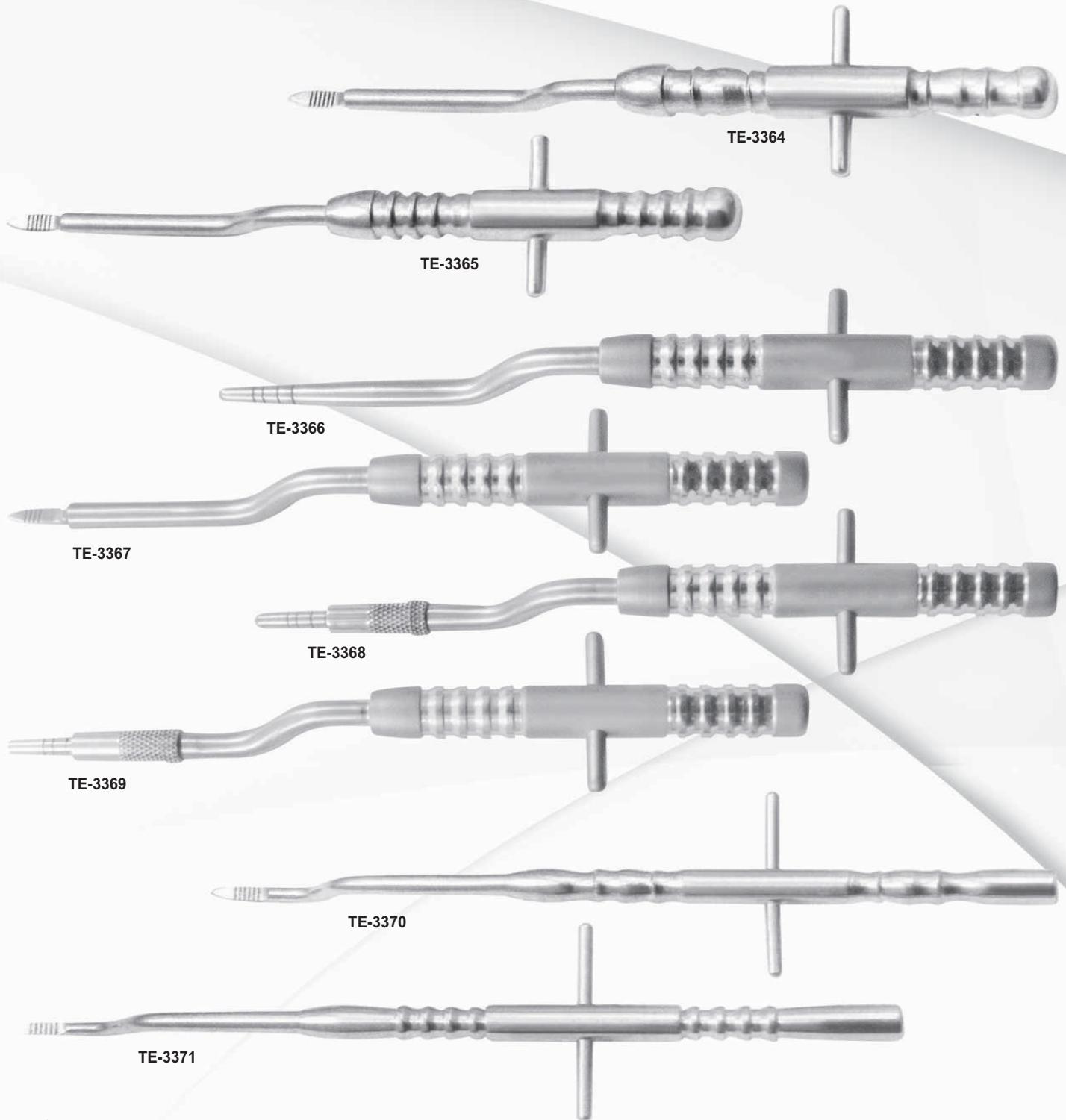

BONE CHISEL & SPREADERS

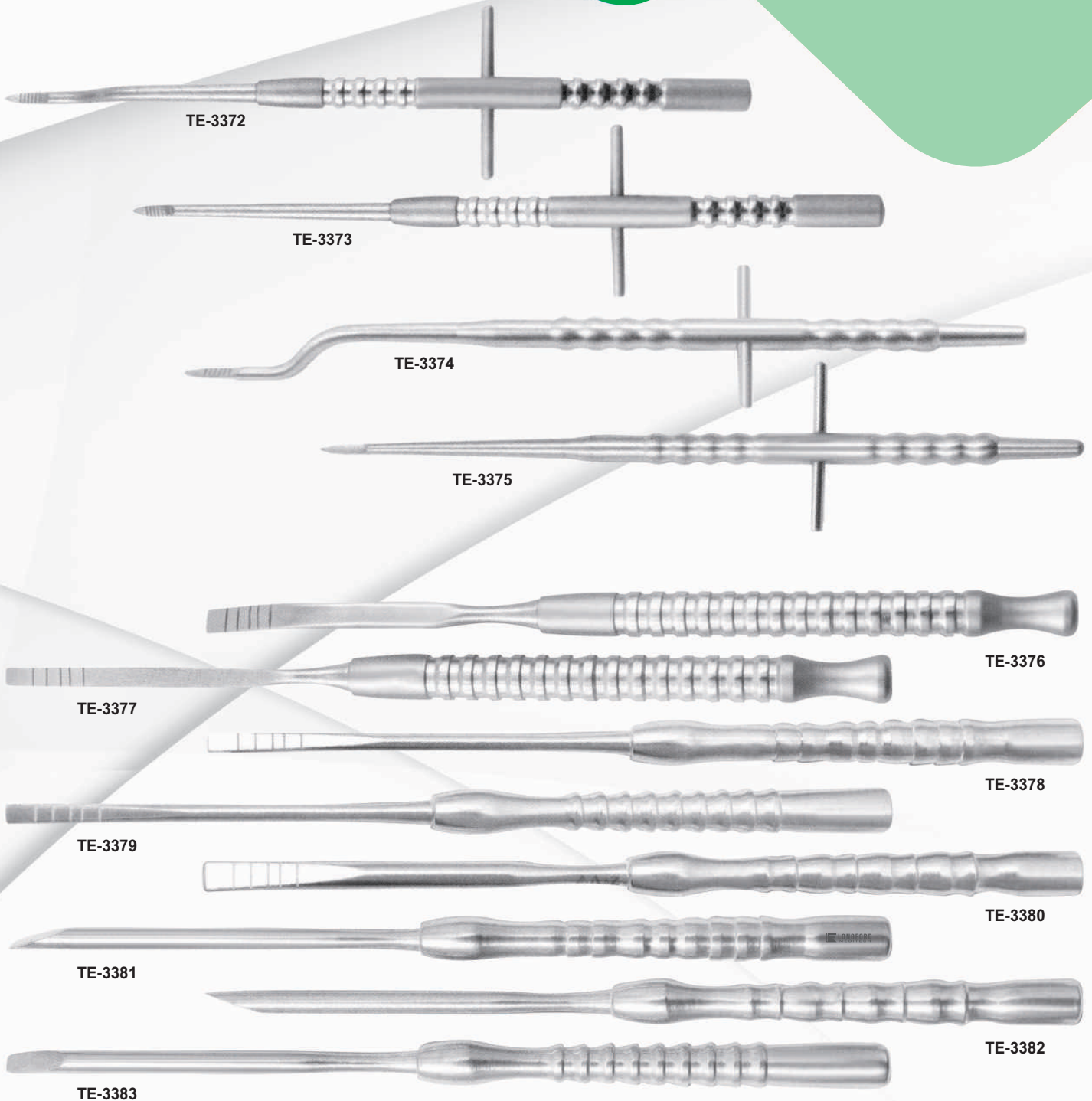

Dental Instruments

OSTEOTOME KITS

Concave



TE-3394
Osteotome Kit
Set of 10 Pieces

Round



TE-3395
Osteotome Kit
Set of 10 Pieces



TISSUE PUNCHES, HAMMER & CALIPERS

Dental Instruments



TE-3406



TE-3407



TE-3408



TE-3409



TE-3410



TE-3411



TE-3412



TE-3413
Boley Decimal Gauge

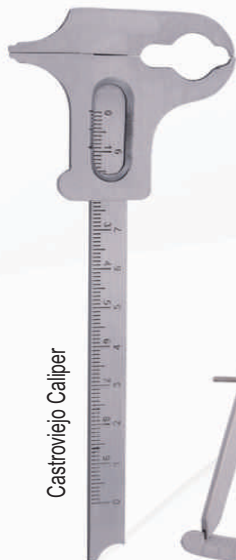

TE-3414
Castroviejo Caliper



TE-3415
Castroviejo Caliper



TE-3416
Ivanson Spring Caliper for Metal / Wax



TE-3417
Bone Caliper - Ridge Mapping



TE-3418
Positive Positioner Gauge



TE-3419
Dontrix Ortho Gauge

Head Office

Opposite Raheem Street Capital
Road Sialkot 51310 - Pakistan.

Whatsapp : +92-3006113341

E-mail info@tollot.biz

Web : www.tollot.biz

